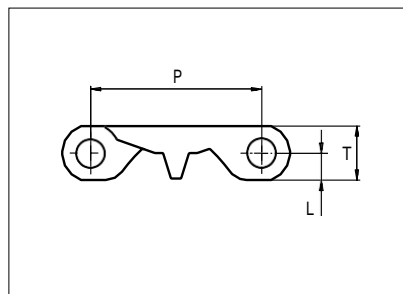

Plastic Modular Belt

 Series **uni MPB** Type **C**

Straight running belt
 Nominal pitch: 50.8 mm (2.00 in)
 Surface type: Flat
 Surface opening: Closed
 Backflex radius: 65.0 mm (2.6 in)
 Pin diameter: 8 mm (0.31 in)

Belt material & color	POM-DI <input type="checkbox"/> W <input type="checkbox"/> B		PP <input type="checkbox"/> W <input type="checkbox"/> B		NBWR <input type="checkbox"/> W		PE- <input type="checkbox"/> N <input type="checkbox"/> B		P (Nominal)	mm	in	T	mm	in
	Pin material & color	<input type="checkbox"/> PP <input type="checkbox"/> W				<input type="checkbox"/> PE <input type="checkbox"/> W				50.8	2.00		16.0	0.63
									L	8.0	0.31	-	-	-

Non standard material and color: See uni Material and Color Overview.

 Alternative pin and lock materials: Pin: PA6.6 N PP W PE W PBT LG SS304

 Lockpin: PA6.6 B PBT LG

 Trilock: PA6.6 N

Belt width		Permissible tensile force (Belt/pin material)								Belt weight (Belt/pin material)								*Min. No. drive sprocket per shaft	Number of wear strips (Min. No.)	
		POM-DI/PP		PP/PP		PE-I/PE		NBWR/PP		POM-DI/PP		PP/PP		PE-I/PE		NBWR/PP			**Carry (pcs)	**Return (pcs)
mm	in	N	lbf	N	lbf	N	lbf	N	lbf	Kg/m	lb/ft	Kg/m	lb/ft	Kg/m	lb/ft	Kg/m	lb/ft			
68	2.7	1870	420	1088	245	884	199	561	126	0.8	0.54	0.6	0.38	0.6	0.40	0.7	0.44	2	2	2
84	3.3	2306	518	1341	302	1090	245	692	155	1.0	0.67	0.7	0.47	0.7	0.50	0.8	0.54	2	2	2
151	5.9	4153	933	2416	543	1963	441	1246	280	1.8	1.21	1.3	0.84	1.3	0.89	1.4	0.97	2	2	2
168	6.6	4620	1039	2688	604	2184	491	1386	312	2.0	1.34	1.4	0.94	1.5	0.99	1.6	1.08	2	2	2
185	7.3	5088	1144	2960	665	2405	541	1526	343	2.2	1.48	1.5	1.03	1.6	1.09	1.8	1.19	2	2	2
202	8.0	5555	1249	3232	727	2626	590	1667	375	2.4	1.62	1.7	1.13	1.8	1.19	1.9	1.30	2	2	2
219	8.6	6023	1354	3504	788	2847	640	1807	406	2.6	1.75	1.8	1.22	1.9	1.30	2.1	1.41	2	2	2
235	9.3	6463	1453	3760	845	3055	687	1939	436	2.8	1.88	2.0	1.31	2.1	1.39	2.3	1.52	2	2	2

Additional standard belt widths are available in steps of 16.8 mm (0.66 in).

655	25.8	18013	4049	10480	2356	8515	1914	5404	1215	7.8	5.24	5.4	3.65	5.8	3.87	6.3	4.23	5	5	3
672	26.5	18480	4154	10752	2417	8736	1964	5544	1246	8.0	5.37	5.6	3.75	5.9	3.97	6.5	4.34	5	5	3
688	27.1	18920	4253	11008	2475	8944	2011	5676	1276	8.2	5.50	5.7	3.84	6.1	4.07	6.6	4.44	5	5	3
705	27.8	19388	4358	11280	2536	9165	2060	5816	1307	8.4	5.64	5.9	3.93	6.2	4.17	6.8	4.55	5	5	3
722	28.4	19855	4463	11552	2597	9386	2110	5957	1339	8.6	5.77	6.0	4.03	6.4	4.27	6.9	4.66	5	5	3

Additional standard belt widths are available in steps of 16.8 mm (0.66 in).

1963	77.3	53983	12135	31408	7061	25519	5737	16195	3641	23.4	15.70	16.3	10.95	17.3	11.61	18.8	12.66	14	14	7
------	------	-------	-------	-------	------	-------	------	-------	------	------	-------	------	-------	------	-------	------	-------	----	----	---

Additional standard belt widths are available in steps of 16.8 mm (0.66 in).

2970	116.9	81675	18361	47520	10682	38610	8680	24503	5508	35.3	23.75	24.7	16.57	26.1	17.56	28.5	19.16	20	20	10
------	-------	-------	-------	-------	-------	-------	------	-------	------	------	-------	------	-------	------	-------	------	-------	----	----	----

General belt tolerance is +0/-0.4% at 23°C/73°F. For exact belt width contact Customer Service. Non standard belt width on request.

*Max. Load per Drive Sprocket. Belt material: POM-DI with snub roller 2000 N (450 lbf) without snub roller 1250 N (281 lbf).

**Max. Spacing between wear strips. Carry: 152 mm (6 in); Return: 304 mm (12 in).

 = Single Link

Distribué par :



Accessories

Rubber Top

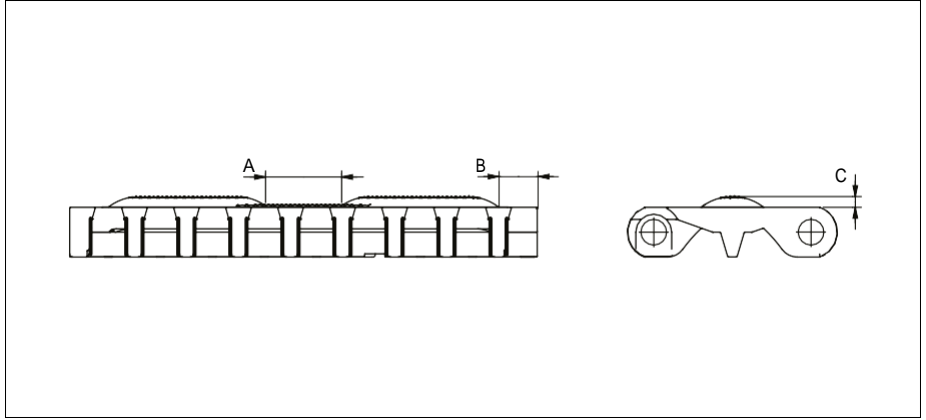
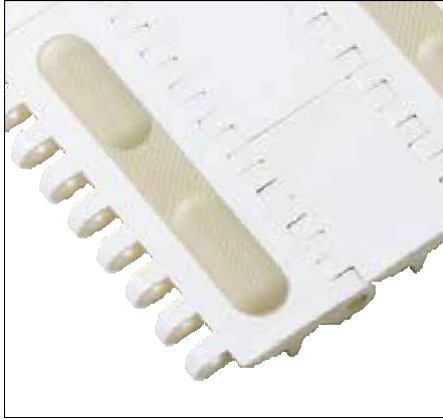

Type	Belt Material & color	Rubber Material & color	A		B		C		Link size	Width	
			mm	in	mm	in	mm	in		mm	in
Curved Rough	POM-DI W	01 N	24.0	0.94	10.0	0.39	3.5	0.14	K600	151.0	5.94

Non Standard material and color: See uni Material and Color Overview.

Accessories

Flight

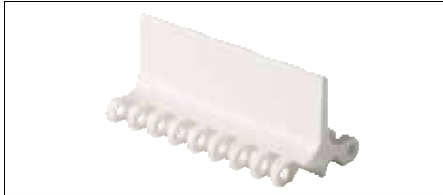

See separate uni MPB series Flight datasheet.

Accessories

Side Guard

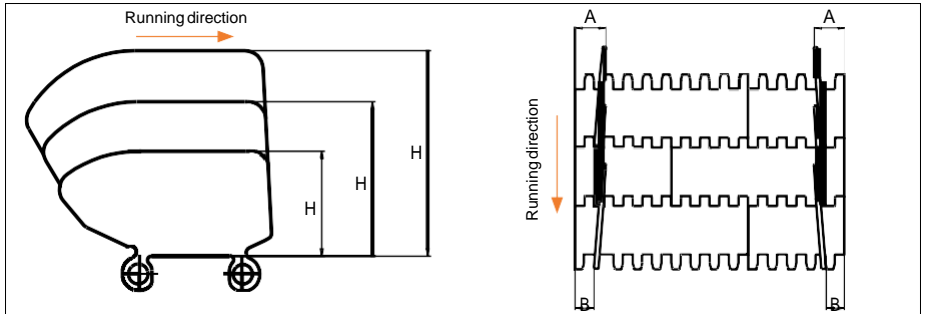

Type	Side Guard Material & color	H		A		B	
		mm	in	mm	in	mm	in
Closed	PE-I B N	50.8	2.00	32.0	1.26	16.0	0.63
	PP-I W B	76.2	3.00				
		101.6	4.00				

*34.0 mm (1.34 in) combined with flight. Increment: 8.4 mm (0.33 in).

Note: Backflex radius when Side Guards are used: 200.0 mm (7.90 in).

Distribué par : 
 Comptoir de Pièces Industrielles et Mécaniques

COPIMEC Sarl au Capital de 8.000.000,00 dh / Adresse: N°237, Rue Oued Ziz – Quartier Industriel - Teldi – AGADIR - MAROC
 TEL : +212 5 28 84 75 61 – +212 5 28 84 75 62 – FAX : +212 5 28 84 73 00 E-mail: contact@copimec.com Web: www.copimec.com

Accessories

Tab

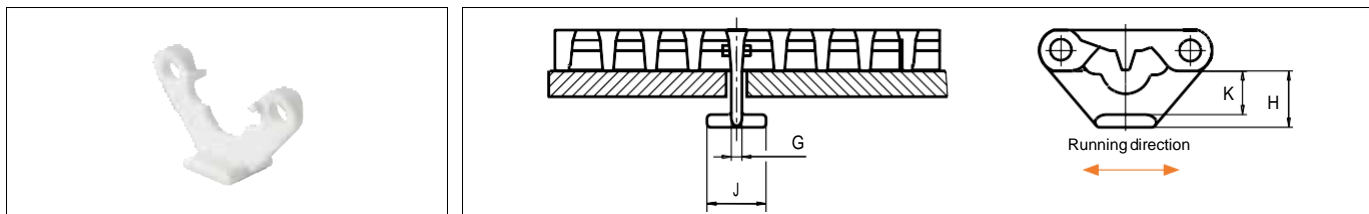

Type	Tab Material & color	G		J		K		H	
		mm	in	mm	in	mm	in	mm	in
Bottom Hold Down	POM-DI W	4.2	0.17	23.2	0.91	17.0	0.67	22.0	0.87

Note: When using tabs, please verify sufficient clearance to the shaft. Max. shaft diameter = Sprocket pitch diameter - 63.5 mm (2.50 in). When using square shafts, please verify that the diagonal does not exceed max. diameter. Example: Sprocket z = 6: Max. shaft diameter 101.6 - 63.5 = ø38.1 mm (4.00 - 2.50 = ø1.4 in).

Note: When using a belt system with tabs, the temperature should be constant. Please note that the tabs are not always placed in the middle of the belt.

Non Standard material and color: See uni Material and Color Overview.

Accessories

Tab/NON STANDARD

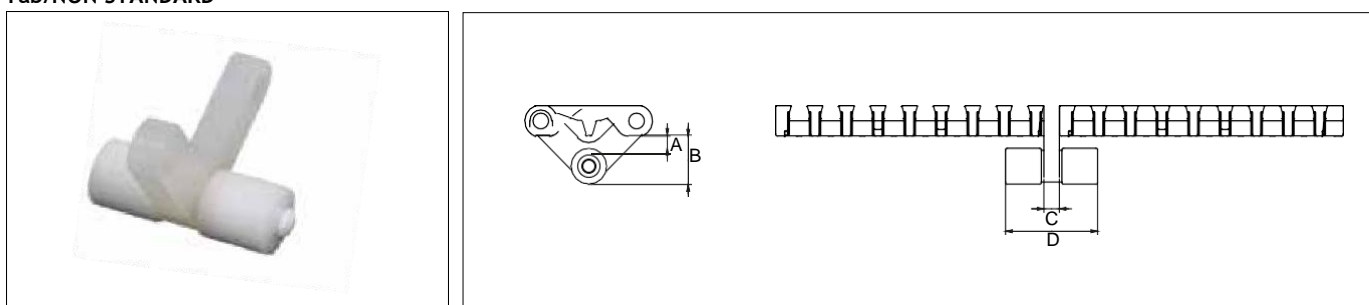

Type	Belt material & color	A		B		C		D	
		mm	in	mm	in	mm	in	mm	in
Bottom Hold Down Roller Tab	PP W	6.5	0.26	25.5	1.00	8.2	0.32	49.0	1.93

Non Standard material and color: See uni Material and Color Overview.

Accessories

Non standard uni AmFlight

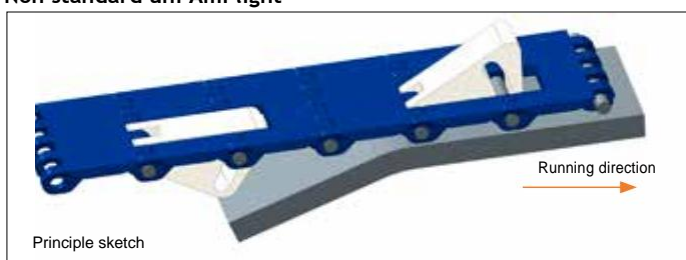

Other non standard option: See uni AmFlight Overview.

Distribué par :



Sprocket

No of teeth	Bore size										Overall diameter		Pitch-diameter		Hub-diameter		Dimension A		Dimension B		Single row/One way	Double row/Two way	Molded PA6 LG	Machined PA6 N
	Pilot bore	1.00			1.50			1.57																
	mm	in	25.4	30.0	31.8	38.1	40.0	60.0	63.5	90.0	mm	in	mm	in	mm	in	mm	in	mm	in				
Z06	✓	●				■	●	■			99.5	3.92	101.6	4.00	65.0	2.56	36.0	1.42	59.3	2.33	✓		✓	
Z08	✓	●				■	●	■			132.9	5.23	132.8	5.23	70.0	2.75	53.3	2.10	74.9	2.94	✓	✓	✓	
Z10	✓		●	●	●	■	■	■	■	■	166.3	6.55	164.4	6.47	¹ 70.0 ² 120.0	2.75 4.72	70.2	2.76	90.7	3.57	✓	✓	✓	
Z12	✓		●	●	●	■	■	■	■	■	198.6	7.82	196.3	7.73	¹ 70.0 ² 120.0 ³ 164.0	2.75 4.72 6.45	86.8 86.8	3.42 3.42	106.6 106.6	4.19 4.19	¹⁺² ✓	²⁺³ ✓	✓	
Z16	✓		●	●	●	■	■	■	■	■	263.8	10.39	260.4	10.25	¹ 150.0 ² 164.0 ³ 200.0	5.90 6.45 7.87	119.7	4.71	138.7	5.46	¹ ✓	²⁺³ ✓	✓	✓

● Molded sprocket ■ Molded sprocket ■ Machined sprocket



Other sprocket sizes are available upon request.
 Other bore sizes on sprockets are available upon request.
 Round bores are always delivered with keyway.
 Max. load per sprocket shown does not take bore size into account.
 Please also ensure that sufficient size shaft is chosen for corresponding load.

Width of tooth = Single row: 9.5 mm (0.37 in)
 = Double row: 17.8 mm (0.70 in)

Width of One-part sprocket = Single row: 42.3 mm (1.66 in)
 = Double row: 42.3 mm (1.66 in)
 = ³Double row: 50.0 mm (1.96 in)

uni UltraClean Two-Part Sprocket

No. of teeth	Bore size				Overall diameter		Pitch-diameter		Hub-diameter		Dimension A		Dimension B		Single row/One way	Moulded PA6 W
	in	1.50	1.57	2.36												
	mm	38.1	40.0	60.0	mm	in	mm	in	mm	in	mm	in	mm	in		
Z8		■	■		132.9	5.23	132.8	5.23	80.0	3.15	53.3	2.10	74.9	2.94	✓	✓
Z10		■	■	■	166.3	6.55	164.4	6.47	¹ 126.0 ² 118.0	¹ 4.96 ² 4.65	70.2	2.76	90.7	3.57	✓	✓
Z12		■	■	■	198.6	7.82	196.3	7.73	¹ 126.0 ² 118.0	¹ 4.96 ² 4.65	86.8	3.42	106.6	4.19	✓	✓

■ Moulded uni UltraClean TwoPart Sprocket

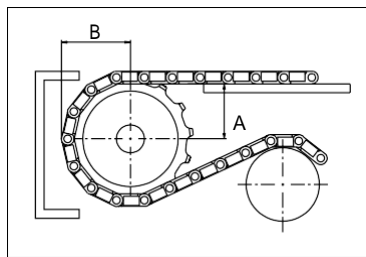

Width of UltraClean Two-part sprocket = Single row: 44.0 mm (1.73 in)
 Width of UltraClean Two-part sprocket, tooth = Single row: 9.5 mm (0.37 in)

uni Retainer Rings: See uni Retainer Ring data sheet.
 For correct sprocket position: See uni Assembly Instructions for uni MPB.
 For more detailed sprocket information, contact Customer Service.

Ammeraal beltech – unichains - copimec



Fabrication & service

Distribué par :

